



Specialised
Orthotic
Services

Units 127/128
Fauld Industrial Park
Tutbury, Nr Burton upon Trent, Staffordshire.
DE13 9HS
Tel: 0044 (0)1283 520 400
Fax: 0044 (0)1283 520 401
E-mail: enquiries@specialorthotic.com
Web: www.specialisedorthoticservices.co.uk

CASTOR OUTRIGGER FITTING INSTRUCTIONS

75mm (3")

CONTENTS

You should have the following:

1. Castor Outrigger Brackets (2 off)
2. 'U' Clamps (2 off)
3. M8 Washers (4 off)
4. M8 Nyloc Nuts (4 off)
5. Rubber End Caps (4 off)
6. M14 x 35mm Bolts (2 off)
7. M14 Spring Washers (2 off)
8. M14 Flat Washers (2 off)
9. Sachet of Loctite 271 (1 off)

If any of the above items are missing, please contact our Customer Services Department on 0044 (0)1283 520400.

1. FITTING

- Loosen and remove existing castor from wheelchair (Fig.1a).
- Remove the two M8 Nyloc nuts and washers and withdraw the 'U' clamp from the bracket (Fig.1b).

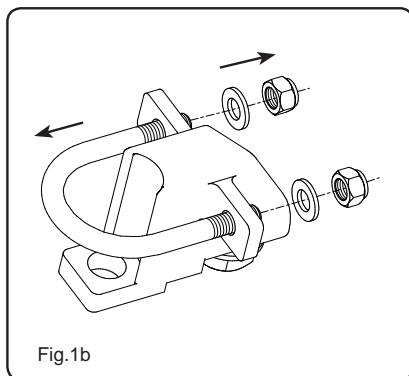
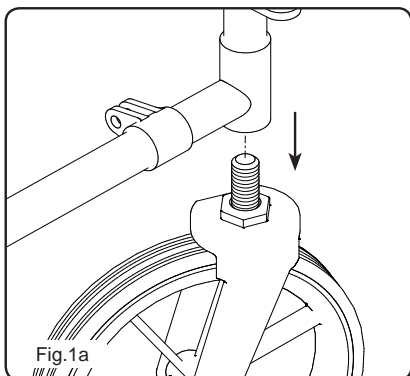

- Remove the M14 bolt from the bracket and align the bracket with the front castor location point on the frame (Fig.1c).
- Apply an even amount of Loctite to the thread of the M14 Bolt and secure the bracket to the wheelchair using the M14 Bolt supplied (Fig.1d), set to a position of 45° then tighten to a torque setting of 61Nm (45ft/lb).

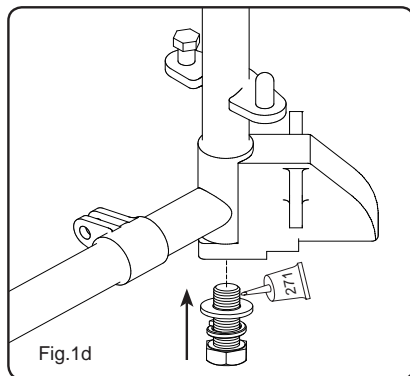
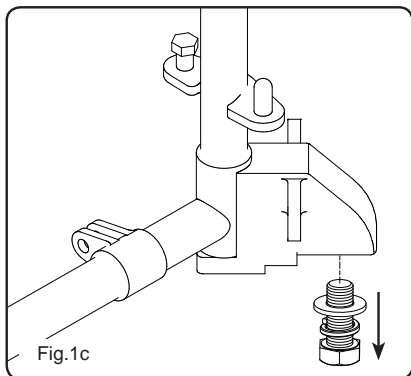

- Fit the 'U' clamp around the wheelchair frame, secure to the bracket with M8 washers and M8 Nyloc nuts supplied (Fig.1e). Ensure all nuts/bolts are securely tightened & fit the rubber end caps supplied.
- Apply an even amount of Loctite to the thread of the castor then screw it into the outrigger bracket (Fig.1f). Tighten to a torque setting of 61Nm (45ft/lb).

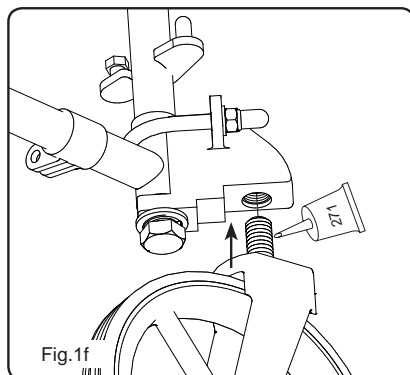
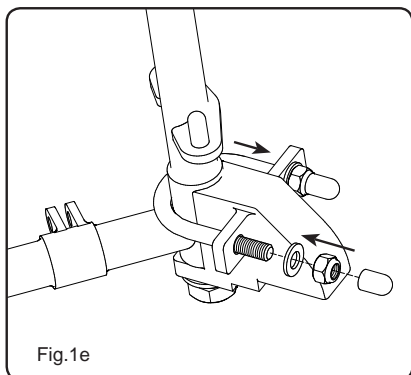

**PLEASE NOTE:
CASTOR OUTRIGGER BRACKETS MUST ALWAYS BE FITTED IN PAIRS**

