



Specialised
Orthotic
Services

Units 127/128
Fauld Industrial Park
Tutbury, Nr Burton upon Trent, Staffordshire.
DE13 9HS
Tel: 0044 (0)1283 520 400
Fax: 0044 (0)1283 520 401
E-mail: enquiries@specialorthotic.com
Web: www.specialisedorthoticservices.co.uk

FOOT RAISER FITTING INSTRUCTIONS

25 x 22mm

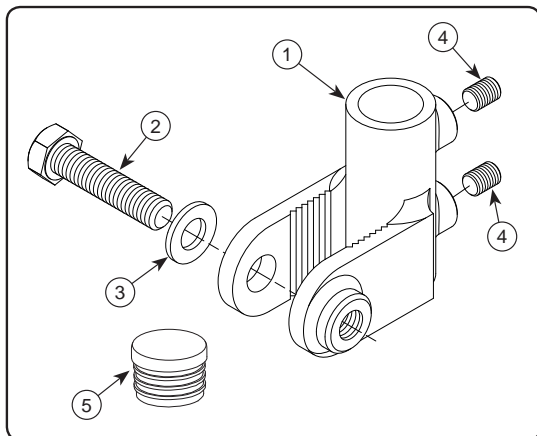

CONTENTS

You should have the following:

1. Foot Raiser Brackets (2 off)
2. M8 Set Screw (2 off)
3. M8 Washers (2 off)
4. M6 Grub Screws (4 off)
5. Plastic Bungs (2 off)

If any of the above items are missing, please contact our Customer Services Department on 0044 (0)1283 520400.

1. FITTING

- Remove the footrest assembly from the wheelchair.
- Loosen the bolt at the bottom of the footrest outer stem and slide the inner stem fully out (Fig.1a).
- Remove the M8 Set Screw and washer from the bracket (Fig.1b).

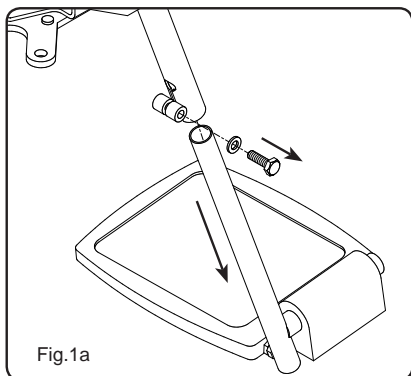

Fig.1a

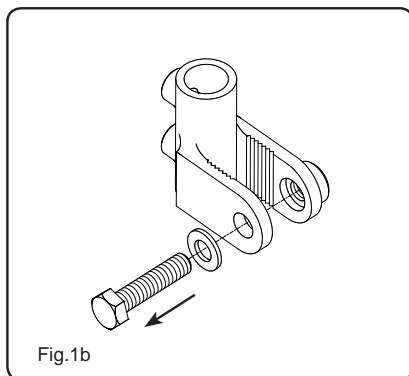
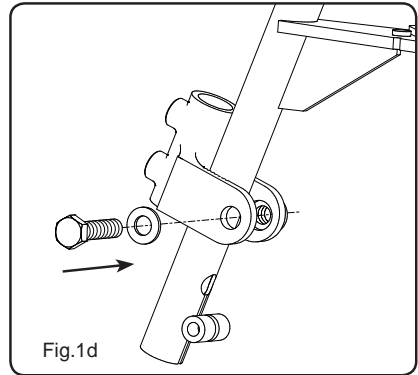
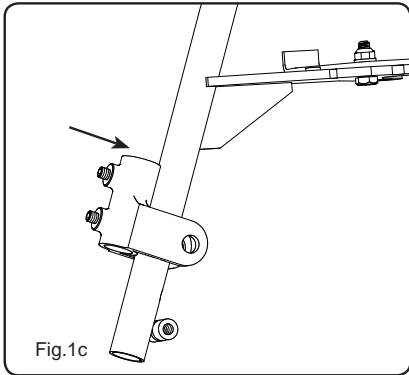
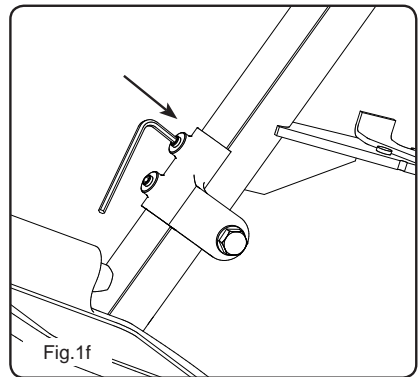
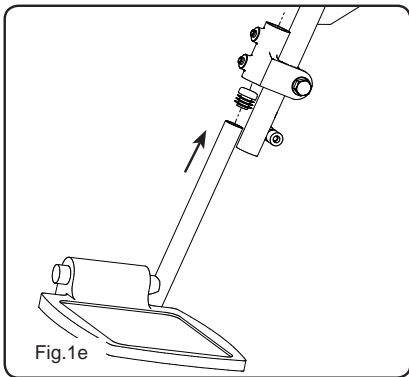

Fig.1b

- Push the Raiser bracket over the footrest outer stem and set it at a position that will give you the desired height adjustment you need to support the clients feet (Fig.1c).
- Insert the M8 Set screw & washer and tighten until the bracket is secure (Fig.1d).



- Push the bung into the open end of the footrest inner stem then insert the footrest inner stem into the body of the Raiser bracket and slide to the desired height (Fig.1e).
- Tighten the M6 grub screw using an Allen key until the footrest is locked into the required position (Fig.1f).



PLEASE NOTE: THE RAISER BRACKET IS NOW SECURE. FURTHER ADJUSTMENT TO THE FOOTREST HEIGHT CAN BE DONE BY LOOSENING THE GRUB SCREWS

